







SK1700

 20 m —  65 m

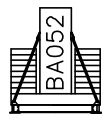
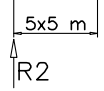
Torre/Masts/Mat/Maste/Măstil/Tramo															
	H[m]	4f/4f BF117	4f/4f BF052	4f/4f BF039	4f/2f SB117	4f/2f SB052	4f/2f SB039	2f/2f ST117	2f/2f ST052	2f/2f ST039	2f/2f STB117	2f/2f STB039	2f/2f RA039	4f/2f SBB039	4f/2f SBB117
TRO 	55.9	2			1			1	1	1					
	52	1			1			2	1						
TTD 	52		3			1			6						
	46.8	1			1			2							
	35.1							3							
	55.9	2			1			1	1	1					
	* 55.9		4									7	1	1	
* 50.7	1											6	1	1	

Torre/Masts/Mat/Maste/Măstil/Tramo															
	H[m]	4f/4f BF117	4f/4f BF052	4f/4f BF039	4f/2f SB117	4f/2f SB052	4f/2f SB039	2f/2f ST117	2f/2f ST052	2f/2f ST039	2f/2f STB117	2f/2f STB039	2f/2f RA039	4f/2f SBB039	4f/2f SBB117
	55.9	1				1		2	2						
	55.9	1	2		1			1	1						
	57.2		4			1			5						
CAF 	52	1			1			2							
	40.3				1			2							
	32.8			1				2							
	* 55.9		3									7	1	1	
	* 55.9	1										6	1		1

Torre/Masts/Mat/Maste/Măstil/Tramo															
	H[m]	4f/4f BF117	4f/4f BF052	4f/4f BF039	4f/2f SB117	4f/2f SB052	4f/2f SB039	2f/2f ST117	2f/2f ST052	2f/2f ST039	2f/2f STB117	2f/2f STB039	2f/2f RA039	4f/2f SBB039	4f/2f SBB117
	50.7	1				1		2	1						
	52	1			1			2							
	52		3			1			5						
CATR 	33.8		1		1			1							
	40.3				1			2							
CATC 	44.2			1	1			2							
	* 52		3									7		1	
	* 52	1										5	1		1

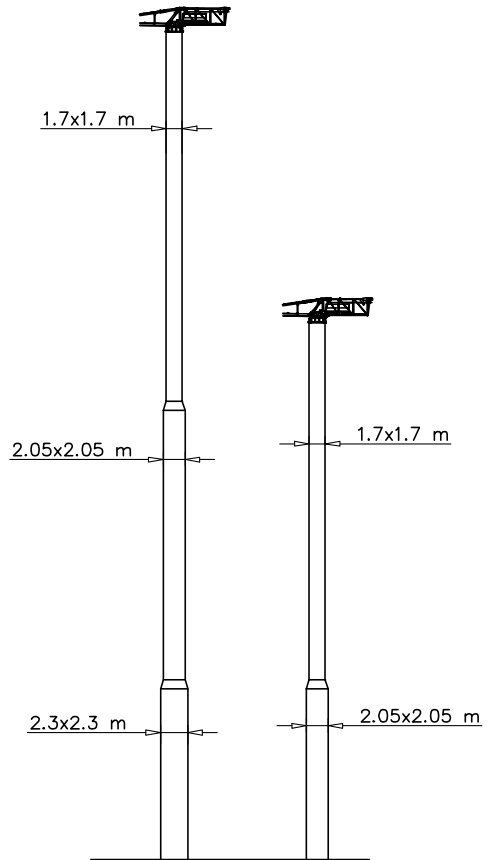

H=0–37 m		H=38–58 m	
R1	95 t	R1	117 t
R2	102 t	R2	122 t
R3	75 t	R3	89 t
M	295 tm	M	347 tm

Peso zavorra—Ballast weight—
Ballastgewicht—Peso de lastre

H	Tot.
0–40 m	70600 kg
40–58 m	105600 kg

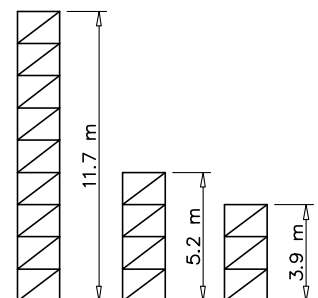



Torre/Reazioni – Masts/Reactions – Mat/Réactions – Maste/Eckdrücke – Mästil/Reacciones – Tramo/Reaçções

SN2050

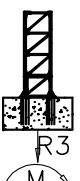
 20 m —→ 65 m

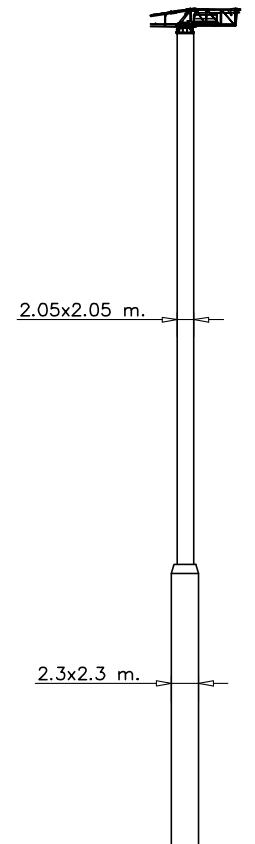

Torre/Masts/Mat/Maste/Mästil/Tramo															
	H[m]	4f/4f BF117	4f/4f BF052	4f/4f BF039	4f/2f SB117	4f/2f SB052	4f/2f SB039	2f/2f ST117	2f/2f ST052	2f/2f ST039	2f/2f STB117	2f/2f STB039	2f/2f RA039	4f/2f SBB039	4f/2f SBB117
TRO 	62.4	2			1			2		1					
	61.1	1	1		1			2	1	1					
TTD 	61.1		4			1			6	1					
	46.8							4							
	52	1	1		1			2							
	62.4		3									10	1	1	
	62.4	1										9	1		1
	62.4	1										11	1	1	

Torre/Masts/Mat/Maste/Mästil/Tramo															
	H[m]	4f/4f BF117	4f/4f BF052	4f/4f BF039	4f/2f SB117	4f/2f SB052	4f/2f SB039	2f/2f ST117	2f/2f ST052	2f/2f ST039	2f/2f STB117	2f/2f STB039	2f/2f RA039	4f/2f SBB039	4f/2f SBB117
	63.7	1			1			3							
	67.6	2			1			2		1					
	67.6		4			1			7						
CAF 	50.7		1			1		3							
	52				1			3							
	*	65		3		1						9	1		
	*	63.7	1									8	1		1
	*	65.3	1				1					10	1		



H=0–45 m		H=46–68 m	
R1	125 t	R1	140 t
R2	130 t	R2	144 t
R3	95 t	R3	103 t
M	486 tm	M	570 tm

Peso zavorra—Ballast weight—
Ballastgewicht—Peso de lastre





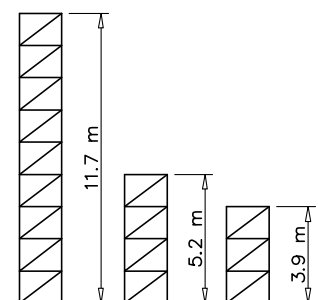





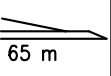

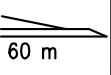

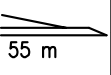
Torre/Masts/Mat/Maste/Mästil/Tramo															
	H[m]	4f/4f BF117	4f/4f BF052	4f/4f BF039	4f/2f SB117	4f/2f SB052	4f/2f SB039	2f/2f ST117	2f/2f ST052	2f/2f ST039	2f/2f STB117	2f/2f STB039	2f/2f RA039	4f/2f SBB039	4f/2f SBB117
	59.8	1			1			2		2					
	59.8		3			1			5	2					
	45.5					1		3							
CATR III CATC 	49.4		1							9					
	32.5				1			1		1					
	*	59.8		3								8	1	1	
	*	59.8	1									9	1	1	
	*	59.8	1									7	1		1

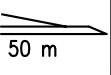
H	Tot.
0–41 m	71900 kg
42–55 m	102320 kg
56–68 m	112460 kg

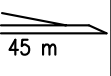

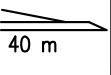

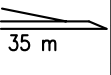

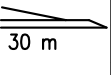





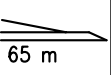

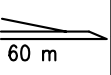

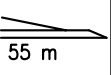
Curve di carico – Courbes de charges – Load diagrams – LastKurven – Curvas de cargas

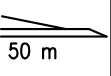
Pmax 4000 kg

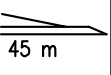
	26520 kg		2.5															28.5	30	35	40	45	50	55	60	65	m
			4000															4000	3750	3050	2650	2300	1950	1700	1500	1400	kg
	24960 kg		2.5														31.5	35	40	45	50	55	60	m			
			4000														4000	3500	3000	2600	2300	2050	1800	kg			
	24960 kg		2.5														33.8	35	40	45	50	55	m				
			4000														4000	3800	3250	2850	2500	2200	kg				
	23400 kg		2.5														37	40	45	50	m						
			4000														4000	3650	3180	2800	kg						
	21840 kg		2.5														40.1	45	m								
			4000														4000	3500	kg								
	20280 kg		2.5														40	m									
			4000														4000	kg									
	18720 kg		2.5														35	m									
			4000														4000	kg									
	15600 kg		2.5														30	m									
			4000														4000	kg									

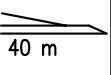

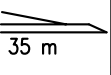

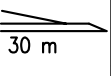





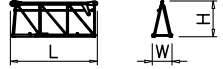
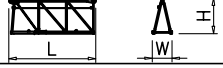



Pmax 8000/4000 kg

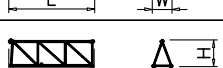
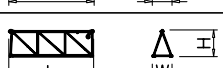
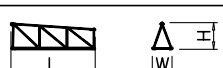



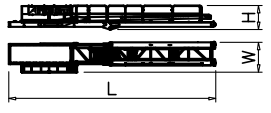

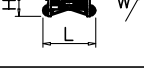
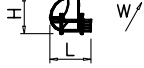
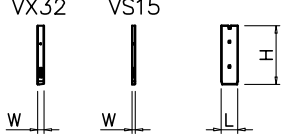

	26520 kg		2.5	15	20	25	28.5	30	35	40	45	50	55	60	65	m
			8000	8000	5850	4600	4000	3750	3050	2650	2300	1950	1700	1500	1400	kg
	24960 kg		2.5	16	20	25	30	31.5	35	40	45	50	55	60	m	
			8000	8000	6700	5200	4250	4000	3500	3000	2600	2300	2050	1800	kg	
	24960 kg		2.5	17	20	25	30	33.8	35	40	45	50	55	m		
			8000	8000	7250	5670	4610	4000	3800	3250	2850	2500	2200	kg		
	23400 kg		2.5	18	20	25	30	35	37	40	45	50	m			
			8000	8000	7200	6300	5125	4300	4000	3650	3180	2800	kg			
	21840 kg		2.5	18.5	20	25	30	35	40.1	45	m					
			8000	8000	7400	6850	5600	4700	4000	3500	kg					
	20280 kg		2.5	18.5	20	25	30	35	40	m						
			8000	8000	7600	7000	5800	4900	4000	kg						
	18720 kg		2.5	18.5	20	25	30	35	m							
			8000	8000	7700	7200	6000	5000	kg							
	15600 kg		2.5	18.5	20	25	30	m								
			8000	8000	7850	7300	6000	kg								

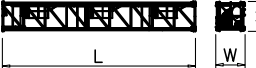

PESI E INGOMBRI – PACKING LIST – LISTE DE COLISAGE – GEWICHT UND ABMESSUNGEN

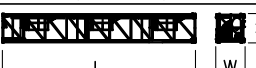
Denominazione Description	Disegno Draw	Pezzi Pieces	Dimensioni-Dimensions (mm)			Peso-Weight (kg)			
			L	W	H	Unit	Total		
Elemento di braccio Jib element Elément de èche Elemento de flecha	n°14		1	5500	1480	2290	2400	–	
	n°13		1	5300	1200	2170	1670	–	
	n°12		1	5280	1200	2170	1400	–	
	n°11		1	5270	1200	2150	1150	–	
	n°10		1	5260	1200	2150	900	–	
	n°9		1	5260	1200	2120	800	–	
	n°8		1	5240	1200	2100	700	–	
	n°7		1	5225	1200	2060	635	–	
	n°6		1	5200	1200	1630	500	–	
	n°5		1	5160	1200	1630	370	–	
	n°4		1	5140	1200	1610	350	–	
	n°3		1	5110	1200	1610	250	–	
	n°2		1	5090	1200	1260	210	–	
	Punta braccio		1	700	1200	500	55	–	
Contorbraccio completo Complete counterjib Contreflèche complète Contraflecha completa		1	12560	1810	1480	5650	–		
Gruppo girevole Slewing group Table tournante Grupo giratorio	SK1700		1	2300	1810	2900	6000	–	
	SN2050		1	2450	1810	2900	6300	–	
Carrello Trolley Chariot Carretilla	P8		1	1600	1620	710	400	–	
Ballatoio con cabina Access balcony with cabin Porte cabine Balcòn corrido con cabina			1	2500	2150	2450	1000	–	
Blocchi contrappeso Counterweight block Contre-poids Bloques de contrapeso	VX32 VS15		VS15	1	1000	200	3550	1560	1560
			VX32	8	1000	400	3550	3120	24960

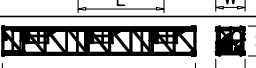
PESI E INGOMBRI – PACKING LIST – LISTE DE COLISAGE – GEWICHT UND ABMESSUNGEN

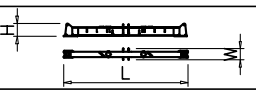
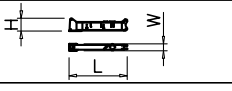
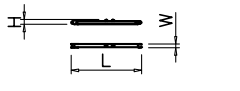
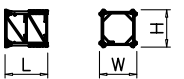
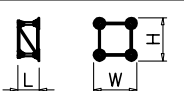
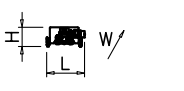
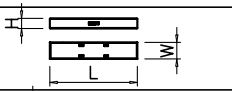
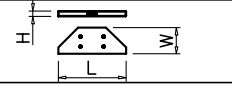
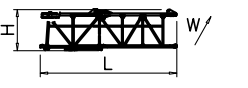
Denominazione Description	Disegno Draw	Pezzi Pieces	Dimensioni-Dimensions (mm)			Peso-Weight (kg)		
			L	W	H	Unit	Total	
Elemento di torre Mast element Elément de mât Elemento de torre	 STD039	SK1700	–	3900	1785	1785	1750	–
		SN2050	–	3900	2110	2110	2320	–
	 STD052	SK1700	–	5200	1785	1785	2250	–
		SN2050	–	5200	2110	2110	2850	–
	 STD117	SK1700	–	11700	1785	1785	4690	–
		SN2050	–	11700	2110	2110	5790	–
	 SB039	SK1700	–	3900	1785	1785	2100	–
		SN2050	–	3900	2110	2110	2710	–
	 SB052	SK1700	–	5200	1785	1785	2600	–
		SN2050	–	5200	2110	2110	3350	–
 SB117	SK1700	–	11700	1785	1785	4830	–	
	SN2050	–	11700	2110	2110	7000	–	
 BF039	SK1700	–	3900	1785	1785	2450	–	
	SN2050	–	3900	2110	2110	3370	–	
 BF052	SK1700	–	5200	1785	1785	3390	–	
	SN2050	–	5200	2110	2110	3880	–	
 BF117	SK1700	–	11700	1785	1785	6920	–	
	SN2050	–	11700	2110	2110	8180	–	
Elemento di base Base element Mat de base Elemento de base	 BA052	SK1700	1	5200	2060	2060	3650	–
		SN2050	1	5200	2260	2260	4040	–
Carro di base Base carriage Chassis de base Cruceta de base		5x5	1	7550	670	780	2300	2300
		6x6	1	8870	670	780	2500	2500
		5x5	2	3530	420	780	1060	2120
		6x6	2	4320	420	780	1200	2400
Puntoni di base Rafter Jambes de force Cabrios de base		5x5	4	4250	240	300	280	1120
		6x6	4	4560	420	300	420	1680
Elemento a perdere Disposable frame Chassis a perdre Bastidor desechable		SK1700	1	1840	1910	1910	1430	–
		SN2050	1	2600	2260	2260	2030	–
Elemento recuperabile Recoverable frame Chassis récupérable Bastidor recuperable		SK1700	1	1300	2170	2170	1720	–
		SN2050	1	1300	2620	2620	1860	–
Bogie di traslazione Driven bogie Boggie motorisèe Balancin de traslaciòn		4	1160	700	600	700	2800	
Blocco zavorra di base Base ballast block Lest de base Blaque de lastre		5x5	2	5300	1000	600	7300	14600
		6x6	2	6400	1200	600	10600	21200
		5x5	–	4100	1600	300	3500	–
		6x6	–	4800	2000	300	5070	–
Corsoio di montaggio Climbing cage Cage de montage Jaula de montaje		SK1700	1	8300	2600	2500	6000	–
		SN2050	1	8300	2900	2700	6700	–

GRU IN CAVEDIO – TELESCOPAGE SUR DALLES – CLIMBING CRANE – KLETTERKRANE IM GEBAUDE

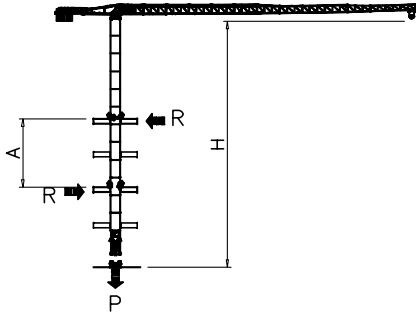

SN2050	H (m)	A (m)	R (t)	P (t)
	9	45.3		
	10	42		
	11	39.3		
	12	37		
	13	35		
	14	33.4		
	15	32		
	16	30.7		
	17	29.6		
	18	28.6		
Apertura passaggio gru Opening for crane passing 	19	27.8		
	20	27		

* SOPRALZO IDRAULICO – TELESCOPABLE – EXTERNAL CLIMBING – KLETTERKRANE

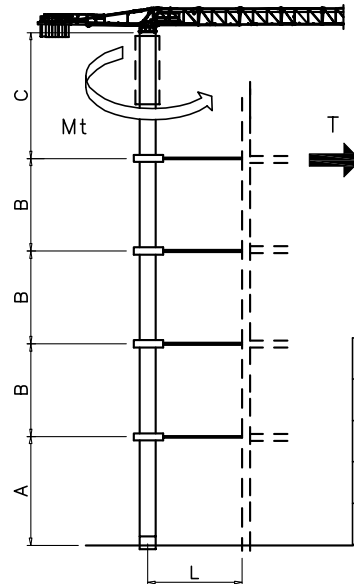
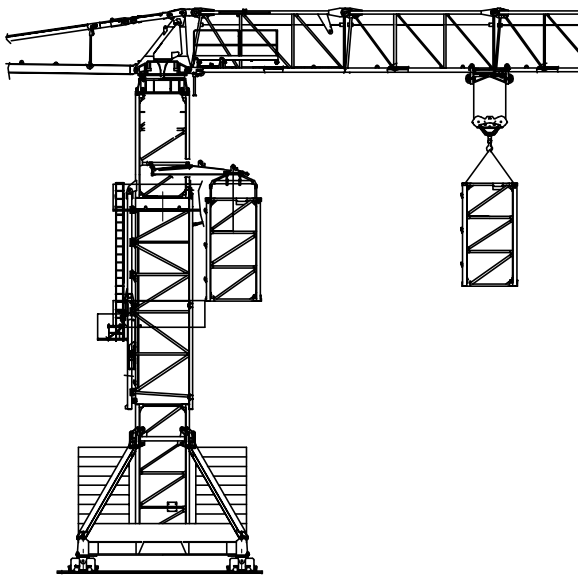

	SK1700	SN2050
C	27.3 m	31.2 m.
B	15.6 m	19.5 m
A	39.5 m	50 m
T	23.4 t	27.5 t
MT	26 t xm	26 t xm

Montaggio – Montage – Erection – Montage – Montaje – Montagem

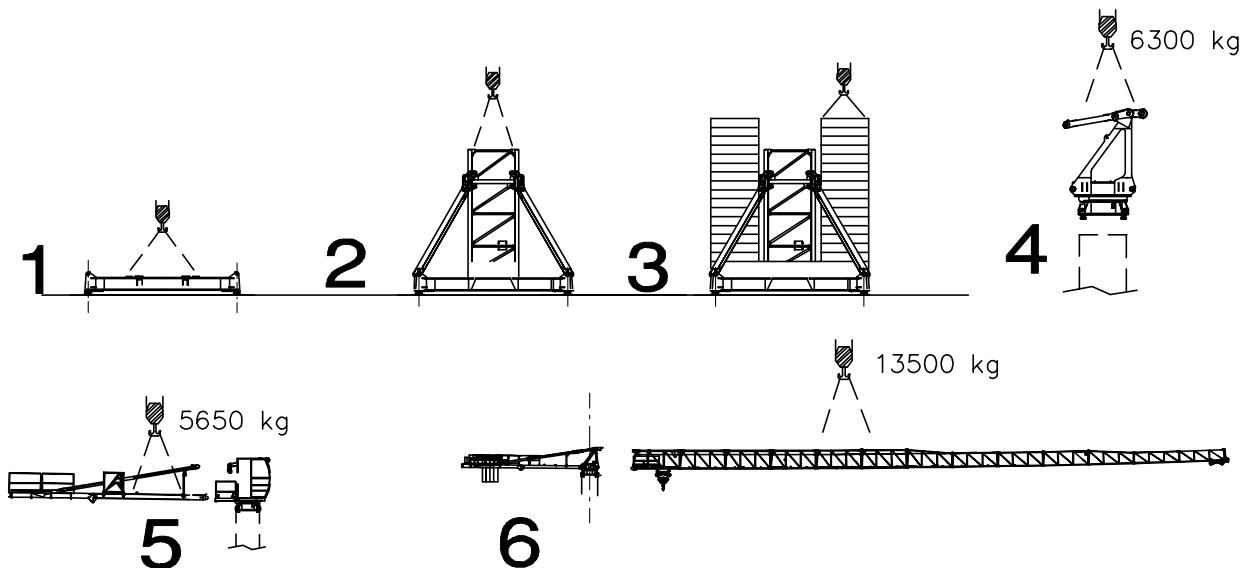

Meccanismi – Mechanisms – Mécanismes – Antriebe – Mecanismos

Sollevamento V33.60 Hoisting Levage Heben Elevaciòn Elevaçao														V33.60 24 kW 40 kVA 260 m
	m/min	2.5	15	27	43	56	71	1.2	7.5	13.5	21.5	28	35.5	
	t	4	4	4	2.5	1.7	0.8	8	8	8	5	3.4	1.6	

Sollevamento V45.90 Hoisting Levage Heben Elevaciòn Elevaçao														V45.90 33 kW 58 kVA 340 m 700 m (L)
	m/min	4	18	36	56	74	90	2	9	18	28	37	45	
	t	4	4	4	3	2	1	8	8	8	6	4	2	

Carrello Trolleying Distribution Katzfahren Distribuciòn Distribuiçao			0 → 80	m/min	4 kW	Potenza elettrica necessaria Puissance électrique nécessaire Necessary electric power Anschlusswert – Potencia
Rotazione Slewing Orientation Schwenken Orientaciòn Rotaçao			0 → 0,9	giri/min tr/min rp/min	4.4 kW @ 1200rpm n° 2 x 2.2 kW	
Traslazione Travelling Translation Kranfahren Traslaciòn Traslaçao			0 → 20	m/min	7.5 kW	

Rete elettrica – Réseau – Mains supply – Netzstrom – Red – Rede electrica	400V – 50 Hz
---	--------------

AFM Gru FMgru s.r.l.
via Emilia 11-29010 Pontenure PC ITALY
tel. 0523/510446 ric.aut. fax 0523/510365
www.fmgru.it e-mail: info@fmgru.com

FEM 1.001
2000/14/CE



Documento commerciale non contrattuale
Per tutte le informazioni tecniche riferirsi
alle corrispondenti istruzioni

Unverbindliches Vertriebsdokument.
Für technische Informationen, siehe die
entsprechenden Anweisungen.

This commercial document is not legally
binding. For any technical information, please
refer to the corresponding instructions.

Documento comercial non contractual
Para cualquier información técnica,
ver la noticia correspondiente.

Code: 15/CA37T50A0		
Ed.	Data	Rev Data
1	25.03.01	2 25.03.10