

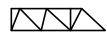

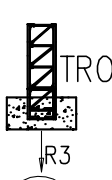

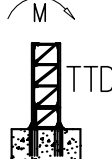

Torre/Reazioni – Masts/Reactions – Mat/Réactions – Maste/Eckdrücke – Mästil/Reacciones – Tramo/Reacções

SH1210

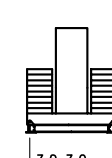
 20 m \rightarrow 47.5 m

Torre/Masts/Mat/Maste/Mästil/Tramo							
 TTR0	H[m]	BL060	B0060	B0120	ST030	ST060	ST120
	42	2f/2f	2f/2f	1		5	
 TTD	42	1	1			5	
	33				1	5	

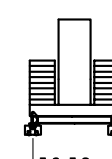
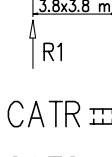
Torre/Masts/Mat/Maste/Mästil/Tramo							
 CAF	H[m]	BL060	B0060	B0120	ST030	ST060	ST120
	42	2f/2f	2f/3f	1		5	
	42	1	1			5	
	33				1	5	

Torre/Masts/Mat/Maste/Mästil/Tramo							
 CATR	H[m]	BL060	B0060	B0120	ST030	ST060	ST120
	36	2f/2f	2f/2f	1		4	
 CATC	36	1	1		2	3	

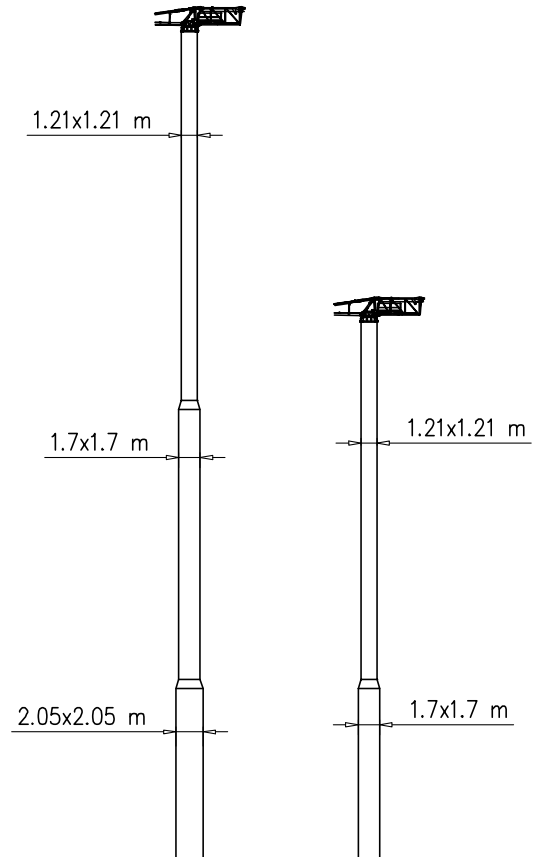

	H=0-23 m	H=24-36 m	H=37-42 m
R1	49 t	53 t	69 t
R2	47 t	53 t	69 t
R3	22 t	25.6 t	40 t
M	80 tm	116 tm	185 tm

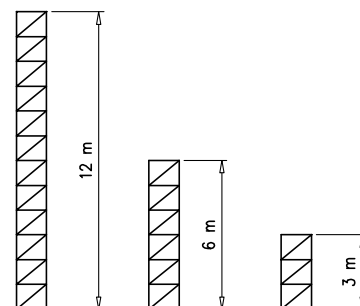

Peso zavorra – Ballast weight – Poids du lest – Ballastgewicht – Peso de lastre

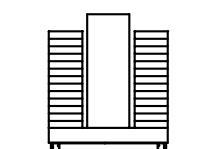



H	Tot.
0-18 m	36000 kg
19-33 m	54000 kg
34-36 m	60000 kg
37-42 m	72000 kg

Torre/Reazioni – Masts/Reactions – Mat/Réactions – Maste/Eckdrücke – Măstil/Reacciones – Tramo/Reacções

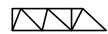
SK1700

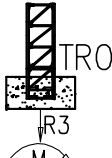
 20 m —→ 47.5 m

Torre/Masts/Mat/Maste/Măstil/Tramo																
		H[m]	4f/4f BF117	4f/4f BF052	4f/4f BF039	4f/2f SB117	4f/2f SB052	4f/2f SB039	2f/2f ST117	2f/2f ST052	2f/2f ST039	2f/2f STB117	2f/2f STB039	2f/2f RA039	4f/2f SBB039	4f/2f SBB117
		54.6							4		2					
		52								10						
		35.1							3							
*		52											11	1		
*		52										1	8	1		

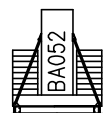
Torre/Masts/Mat/Maste/Măstil/Tramo																
		H[m]	4f/4f BF117	4f/4f BF052	4f/4f BF039	4f/2f SB117	4f/2f SB052	4f/2f SB039	2f/2f ST117	2f/2f ST052	2f/2f ST039	2f/2f STB117	2f/2f STB039	2f/2f RA039	4f/2f SBB039	4f/2f SBB117
 4.5x4.5 m R2 CAF H > 50 5x5 m.		59.8							4		2					
		59.8								9	2					
		40.3							3							
*		52											11	1		
*		52										1	8	1		

Torre/Masts/Mat/Maste/Măstil/Tramo																
		H[m]	4f/4f BF117	4f/4f BF052	4f/4f BF039	4f/2f SB117	4f/2f SB052	4f/2f SB039	2f/2f ST117	2f/2f ST052	2f/2f ST039	2f/2f STB117	2f/2f STB039	2f/2f RA039	4f/2f SBB039	4f/2f SBB117
 4.5x4.5 m R1 CATR CATC H > 50 5x5 m.		52							4							
		52								9						
		40.3							3							
*		52											11	1		
*		52										1	8	1		

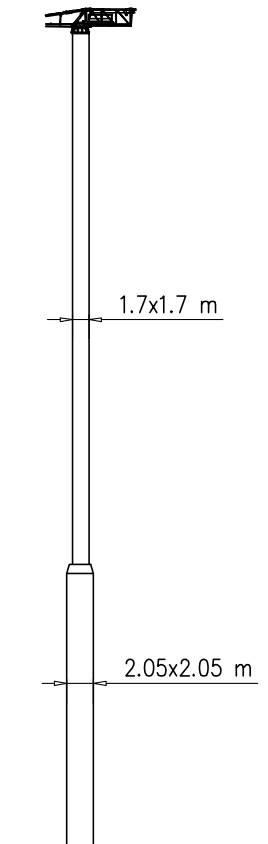

H=0-35 m	
R1	65 t
R2	65 t
R3	54 t
M	156 tm

H=36-45 m	
R1	72 t
R2	72 t
R3	61 t
M	194 tm

H=46-58 m	
R1	106 t
R2	106 t
R3	95 t
M	336 tm



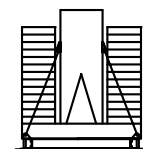



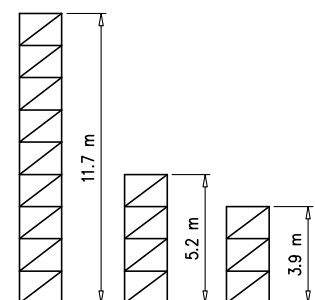





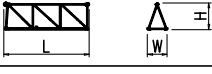

Peso zavorra-Ballast weight-Poids du lest
Ballastgewicht-Peso de lastre

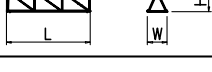
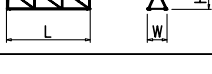



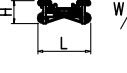
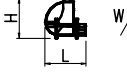



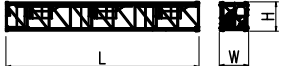

H	Tot.
0-35 m	60800 kg
36-45 m	72000 kg
46-58 m	105000 kg

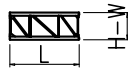
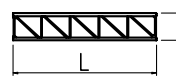
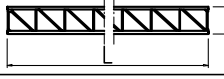

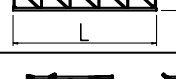
PESI E INGOMBRI – PACKING LIST – LISTE DE COLISAGE – GEWICHT UND ABMESSUNGEN

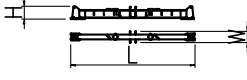
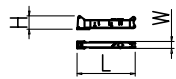
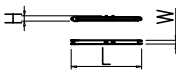
Denominazione Description	Disegno Draw	Pezzi Pieces	Dimensioni-Dimensions (mm)			Peso-Weight (kg)		
			L	W	H	Unit	Total	
Elemento di braccio Jib element Elément de èche Elemento de flecha	n°9 	1	5500	1480	2290	1163	–	
	n°8 	1	5260	1200	2150	722	–	
	n°7 	1	5225	1200	2060	635	–	
	n°6 	1	5200	1200	1630	500	–	
	n°5 	1	5160	1200	1630	370	–	
	n°4 	1	5140	1200	1610	350	–	
	n°3 	1	5110	1200	1610	250	–	
	n°2 	1	5090	1200	1260	210	–	
	n°1 	1	5090	1200	1260	200	–	
	Punta braccio 	1	700	1200	500	55	–	
Controbraccio completo Complete counterjib Contreflèche complète Contraflecha completa		1	10660	1750	1480	1850	–	
Gruppo girevole Slewing group Table tournante Grupo giratorio	SK1700 	1	2300	1810	2900	5900	–	
	S1200 	1	2450	1810	2900	3000	–	
Carrello Trolley Chariot Carretilla	P6 	1	1600	1620	710	320	–	
Ballatoio con cabina Access balcony with cabin Porte cabine Balcòn corrido con cabina		1	2500	2150	2450	1000	–	
Blocchi contrappeso Counterweight block Contre-poids Bloques de contrapeso	VX24 	VS12	2	1000	200	2500	1200	2400
	VS12 							
Elemento di torre Mast element Elément de mature Elemento de torre	STD039 	SK1700	–	3900	1785	1785	1750	–
	STD052 	SK1700	–	5200	1785	1785	2250	–
	STD117 	SK1700	–	11700	1785	1785	4690	–

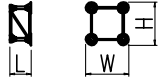
PESI E INGOMBRI – PACKING LIST – LISTE DE COLISAGE – GEWICHT UND ABMESSUNGEN

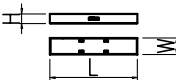
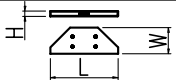
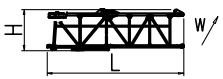
Denominazione Description	Disegno Draw	Pezzi Pieces	Dimensioni-Dimensions (mm)			Peso-Weight (kg)		
			L	W	H	Unit	Total	
Elemento di torre Mast element Elément de mât Elemento de torre	ST030 	SH1210	-	3000	1210	1210	840	-
	ST060 	SH1210	-	6000	1210	1210	1490	-
	ST120 	SH1210	-	12000	1210	1210	3000	-
	BO060 	SH1210	-	6000	1210	1210	2120	-
	BO120 	SH1210	-	12000	1210	1210	3500	-
	BL060 	SH1210	-	6000	-	-	-	-
Elemento di base Base element Mat de base Elemento de base	BA052 	SK1700	1	5200	2060	2060	3650	-
Carro di base Base carriage Chassis de base Cruceta de base		3.2x3.2	1	4670	520	660	1160	1160
		3.8x3.8	1	5700	520	660	2280	2280
		4.5x4.5	1	6670	670	780	2040	2040
		5x5	1	7550	670	780	2300	2300
		3.2x3.2	2	2180	340	660	550	1100
		3.8x3.8	2	2700	340	660	1090	2180
		4.5x4.5	2	3180	420	780	980	1960
		5x5	2	3530	420	780	1060	2120
Puntoni di base Rafter Jambes de force Cabrios de base		4.5x4.5	4	4070	240	300	270	1080
		5x5	4	4250	240	300	280	1120
Elemento a perdere Disposable frame Chassis a perdre Bastidor desechable		SH1210	1	2015	1210	1210	800	-
		SK1700	1	1840	1910	1910	1430	-
Elemento recuperabile Recoverable frame Chassis récupérable Bastidor recuperable		SH1210	1	400	1700	1700	610	-
		SK1700	1	1300	2170	2170	1720	-
Bogie di traslazione Driven bogie Boggie motorisée Balancin de traslaciòn			4	1160	700	600	700	2800
Blocco zavorra di base Base ballast block Lest de base Bloque de lastre		3.2x3.2	-	3600	1150	300	3000	-
		3.8x3.8	-	4000	1200	270	3000	-
		4.5x4.5	2	5000	750	600	5175	10350
		5x5	2	5300	1000	600	7300	14600
		4.5x4.5	-	3600	1450	300	2800	-
		5x5	-	4100	1600	300	3500	-
Corsoio di montaggio Climbing cage Cage de montage Jaula de montaje		SH1210	1	8300	1600	1500	3000	-
		SK1700	1	8300	2600	2500	6000	-

GRU IN CAVEDIO – TELESCOPAGE SUR DALLES – CLIMBING CRANE – KLETTERKRANE IM GEBAUDE

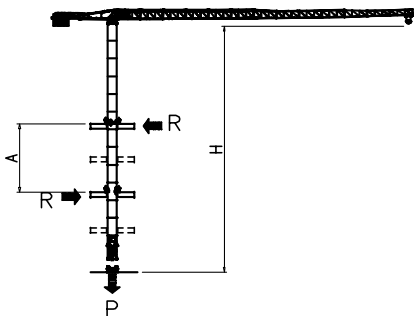

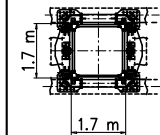
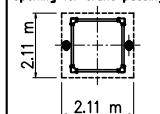
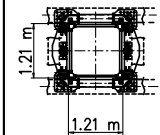
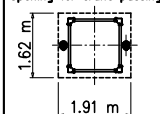
S1700	H (m)	A (m)	R (t)	P (t)	SH1210	H (m)	A (m)	R (t)	P (t)
 Apertura passaggio gru Opening for crane passing 	50.8	9	45.3		 Apertura passaggio gru Opening for crane passing 	30	6	25.75	33
		10	42						
		11	39.3						
		12	37						
		13	35						
		14	33.4						
		15	32						
		16	30.7						
		17	29.6						
		18	28.6						
		19	27.8						
20	27								

SOPRALZO IDRAULICO – TELESCOPABLE – EXTERNAL CLIMBING – KLETTERKRANE

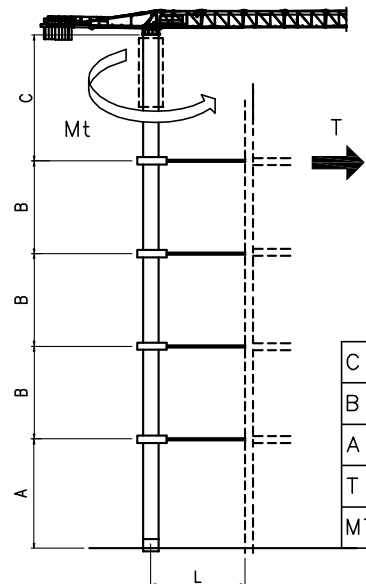
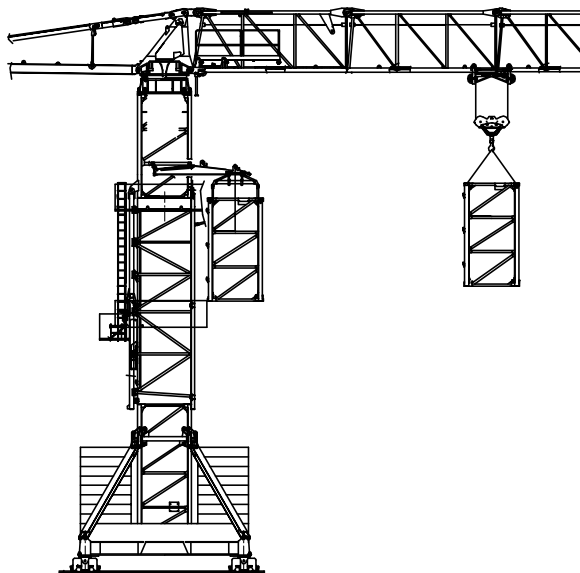

	SH1210	SK1700
C	27.3 m	27.3 m
B	17 m	15.6 m
A	32 m	39.5 m
T	19 t	23.4 t
MT	23 t xm	26 t xm

Montaggio – Montage – Erection – Montage – Montaje – Montagem

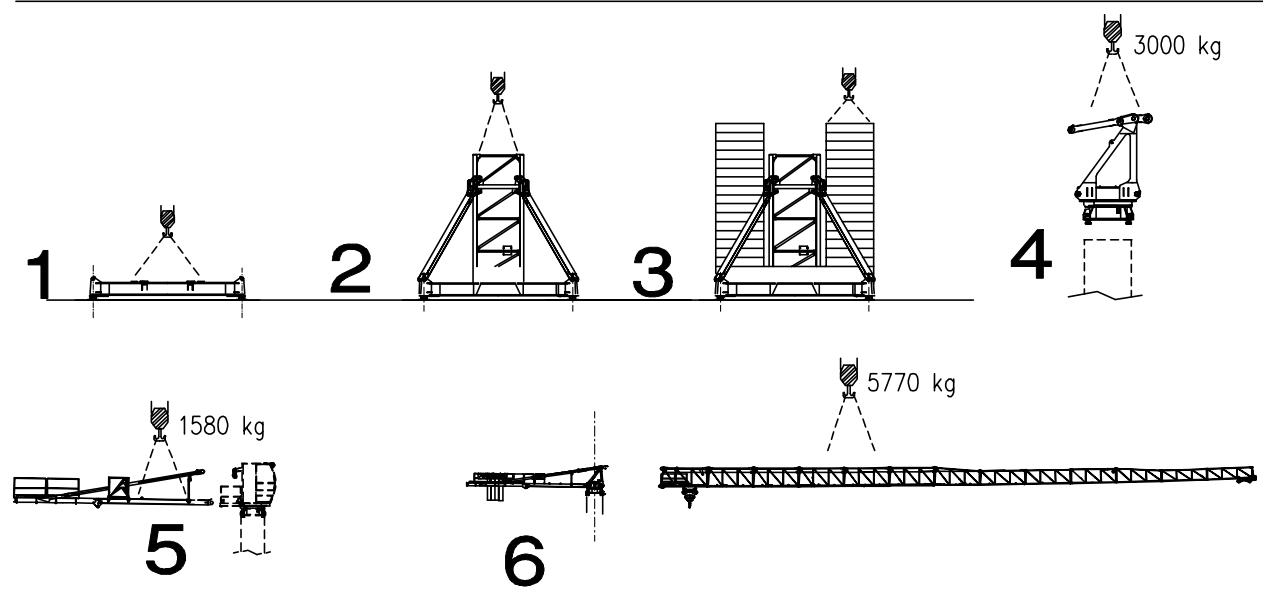

Meccanismi – Mechanisms – Mécanismes – Antriebe – Mecanismos

Sollevamento V15.40 Hoisting Levage Heben Elevaciòn Elevaçao												V15.40 11 kW 20 kVA 172 m
	m/min	5	13	19	30	45	2.5	6.5	9.5	15	22.5	
	t	2	2	2	1.4	0.56	4	4	4	2.8	1.12	

Sollevamento V15.40 Hoisting Levage Heben Elevaciòn Elevaçao								V15.40 11 kW 20 kVA 172 m
	m/min	5	13	19	30	45		
	t	2.5	2.5	1.9	1.4	0.56		

Sollevamento V25.60 Hoisting Levage Heben Elevaciòn Elevaçao													V25.60 18.4 kW 37 kVA 172 m	
	m/min	7	18	28	42	56	65	3.5	9	14	21	28		32.5
	t	3	3	3	2.25	1.5	0.9	6	6	6	4.5	3		1.8

Carrello Trolleying Distribution Katzfahren Distribuciòn Distribuiçao			0 → 55	m/min	2.2 kW	Potenza elettrica necessaria Puissance électrique nécessaire Necessary electric power Anschlusswert – Potencia
Rotazione Slewing Orientation Schwenken Orientaciòn Rotaçao			0 → 0,9	giri/min tr/min rp/min	2.2 kW @ 1200rpm	
Traslazione Travelling Translation Kranfahren Traslaciòn Traslaçao			0 → 20	m/min	3.7 kW	

Rete elettrica – Réseau – Mains supply – Netzstrom – Red – Rede electrica	400V – 50 Hz
---	--------------

AFM Gru FMgru s.r.l.
via Emilia 11-29010 Pontenure PC ITALY
tel. 0523/510446 ric.aut. fax 0523/510365
www.fmgru.it e-mail: info@fmgru.com

FEM 1.001
2000/14/CE



Documento commerciale non contrattuale
Per tutte le informazioni tecniche riferirsi
alle corrispondenti istruzioni

Unverbindliches Vertriebsdokument.
Für technische Informationen, siehe die
entsprechenden Anweisungen.

This commercial document is not legally
binding. For any technical information, please
refer to the corresponding instructions.

Documento comercial no contractual
Para cualquier información técnica,
ver la noticia correspondiente.

Code: 15ICA37T25AO		
Ed.	Data	Rev Data
1	30.09.08	2 26.02.10